

**CABROL**<sup>®</sup>  
G R O U P

ESTD: 1989

Complete Wire & Cable packaging solutions

## Company Highlights & Key Features

- Introduced the concept of Collapsible Steel Drums (CKD) to India in 1989 and are the leading manufacturers and exporters of Steel Cable Drums to the industry.
- Acquired high level of expertise and hands on experience due to our decades of association with the Cable & Conductor Industry.
- Three state of the art manufacturing units, (2 in India & 1 in Sultanate of Oman) spread over an area of 40,000 sq. ft each with an annual production capacity of 12000 metric tons.
- Exporters of Steel Cable Drums for over two decades.
- High quality drums at economical prices with quick lead times.
- Customizable drums as per the clients specifications.
- Capabilities to design Steel Cable Drums on CAD systems, with in house engineers.
- We manufacture reels according to DIN, Western Electric, NEMA & Aluminum Association Standards.
- Preferred vendors of our clients due to our efficient customer service.
- Recognized Government of India Export House  
(Awarded Star Export House for Sizeable exports since 2004)

## Advantages of 'Steel Drums'

- Cost effective
- Reusable
- No Nails
- Weather Proof
- Environmental Friendly
- Easily Disposable
- Better Safety of Cable / Conductor
- Recover at Least 35% Value of the Drums by Scrapping It
- Higher Reliability, Better Strength & More Durability than Wooden Drums
- Lower Transportation Costs
- Less Storage Space (in CKD form)
- CKD drums reduces recycling costs drastically

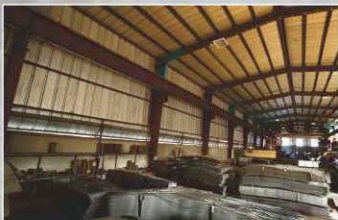
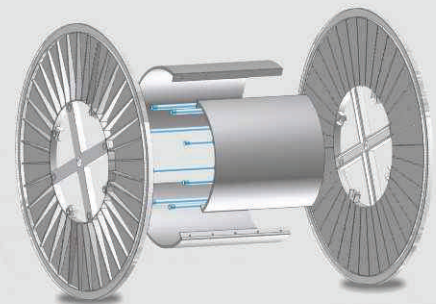

State of the art manufacturing facilities

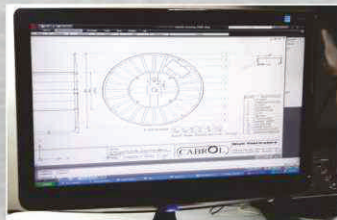

Professional CAD Designing



In house machining & engineering



High Quality Drums Ready to Dispatch

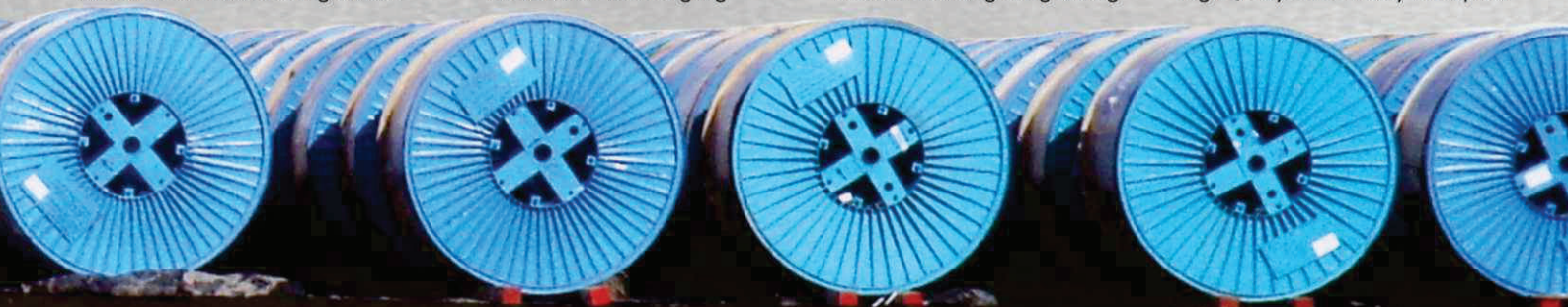

Customizable Options



Cable Slot in Flange [SIF]



Groove On Outer Rim [T Beam]



Slot for Wooden Lagging [SWL]



Cable Slot in Drum [SID]

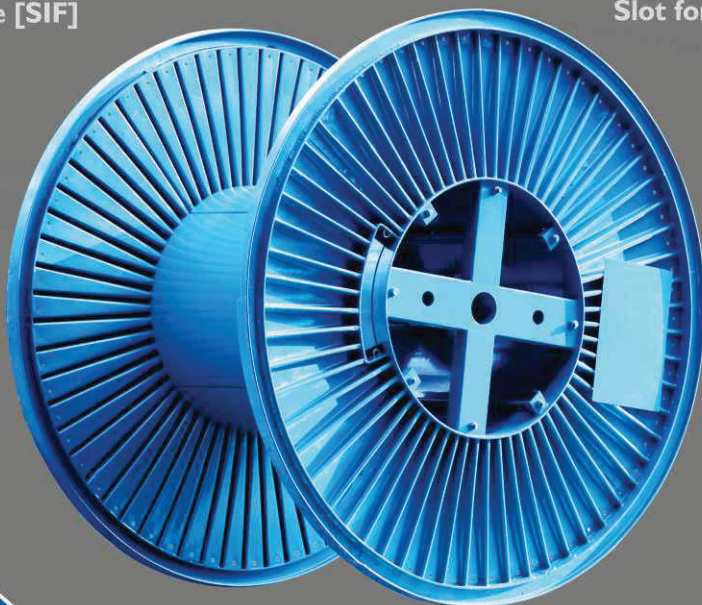

Tying Holes [TH]



Cable Guide Plank [GP]



Holes On Outer Rim [HR]



Tying Bars [TB]

Easy Assembly

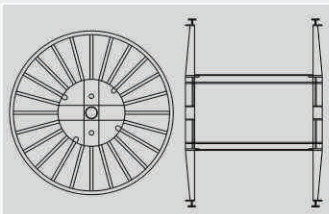
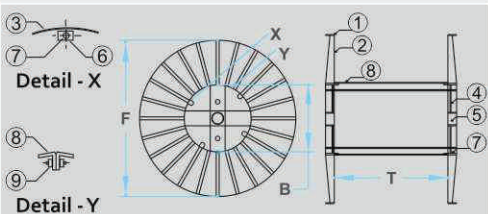
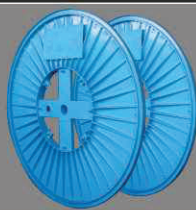

No	Description	No	Description
1	Outer Ring	7	Tierod with Nut, Washer
2	Corrugated Sheet	8	Barrel Sheet
3	Inner Ring	9	Hex Bolt, Nut, Washer & Spring Washer
4	Cross Arm	F	Flange Dia
5	Centre Hub	B	Barrel Dia
6	Tierod Holder	T	Traverse



**CABROL**<sup>®</sup>  
G R O U P  
ESTD: 1989





 **Corporate Headquarters:**  
127, Sheraton Classic, 104 / A wing,  
Dr. Charat Singh Colony Road,  
Andheri (E), Mumbai - 400093  
INDIA  
Tel.: +91 22 28311494 / 99  
Fax.: +91 22 28313672  
<http://www.cabrolgroup.com>  
[info@cabrolgroup.com](mailto:info@cabrolgroup.com)

 **Marketing Office:**  
5600 Northwest Central Drive,  
Suite: 206, Houston TX 7709  
USA  
Tel: +1 (713) 851 5713  
<http://www.steelcablereels.com>  
[info@steelcablereels.com](mailto:info@steelcablereels.com)



 **Manufacturing Facility:**  
Palghar, Maharashtra  
INDIA

 **Manufacturing Facility:**  
Dhrangadhra, Gujarat  
INDIA

 **Manufacturing Facility:**  
Sohar  
SULTANATE OF OMAN

[www.cabrolgroup.com](http://www.cabrolgroup.com)